

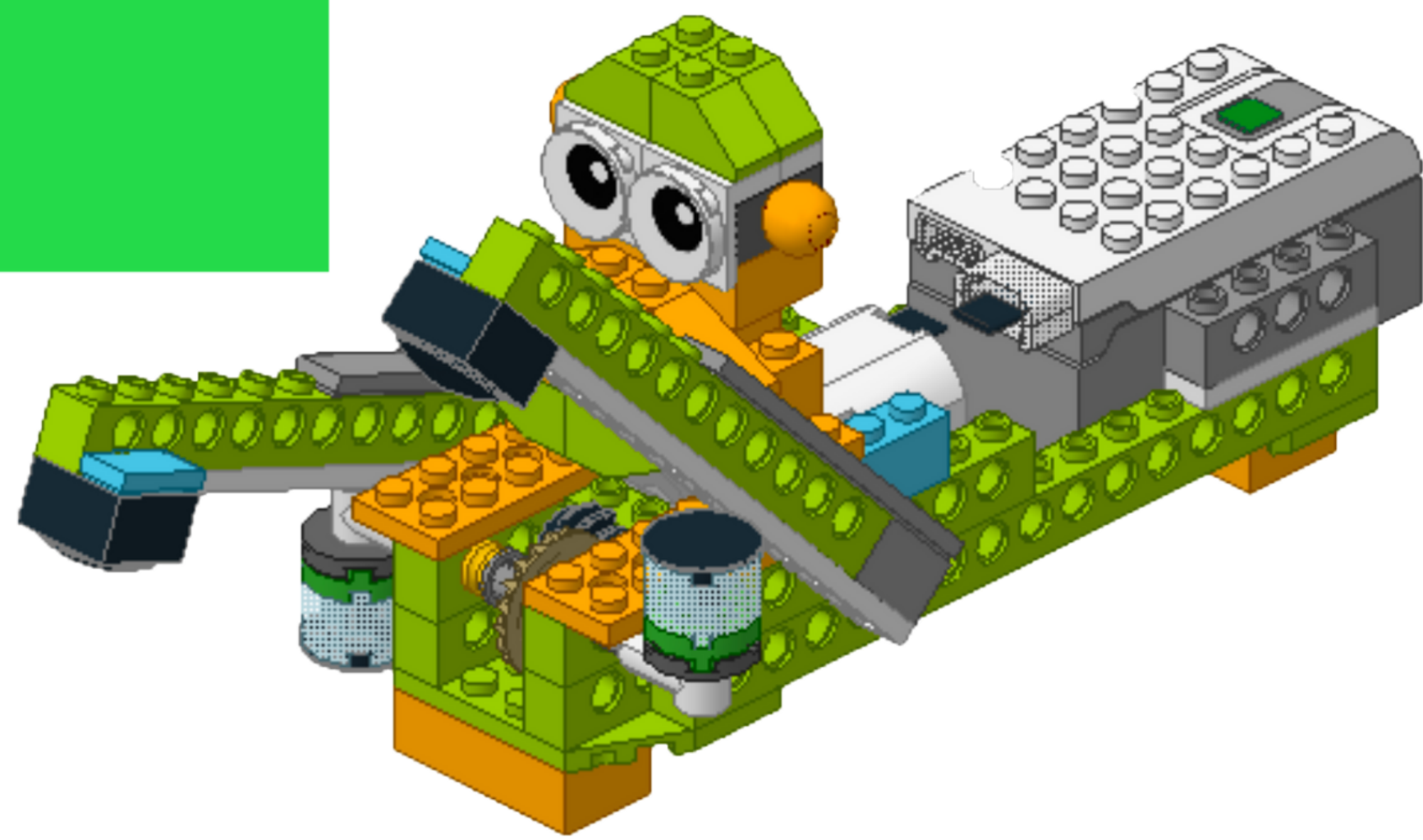

LEGO
bot.ru

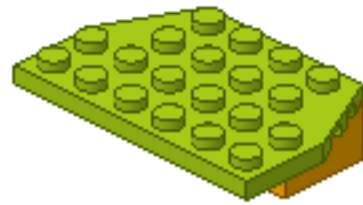

1

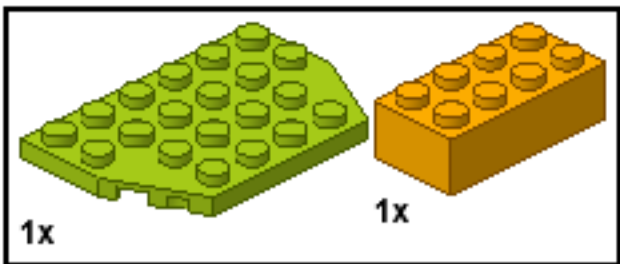

2

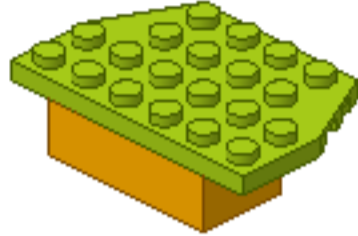
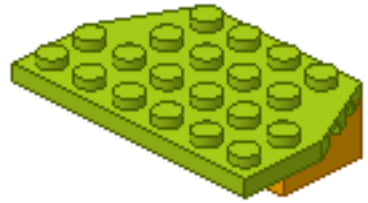
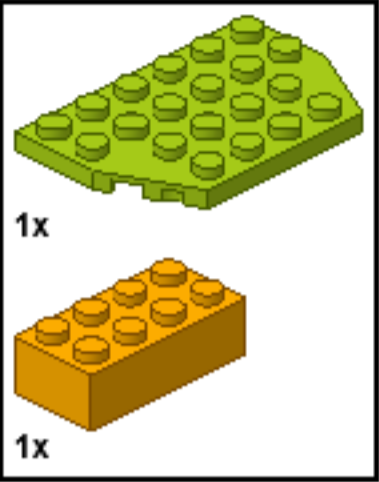

3

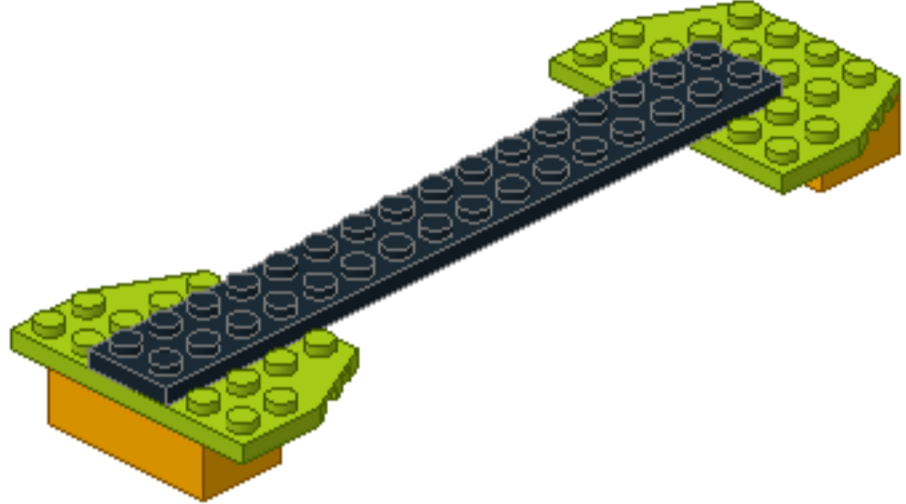
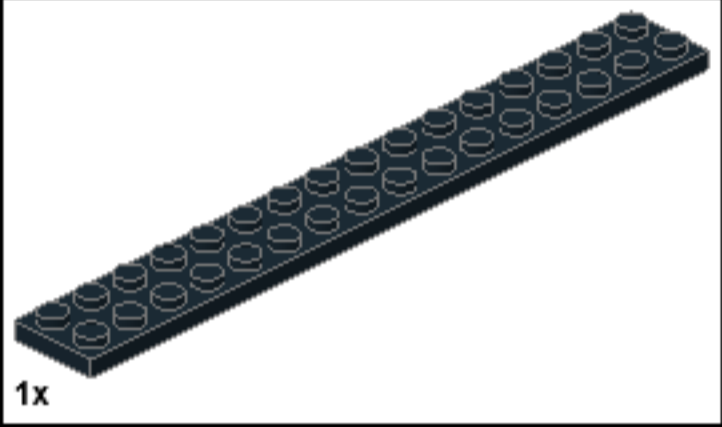

4

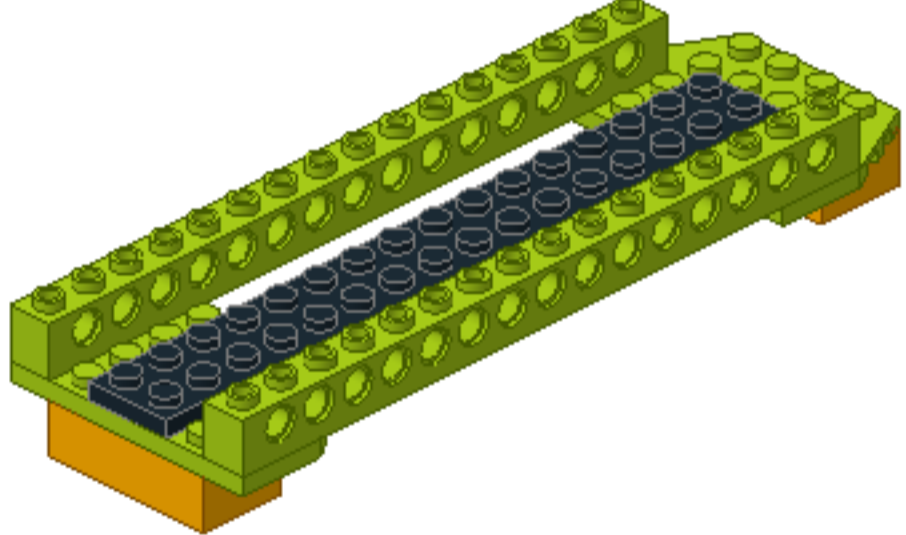
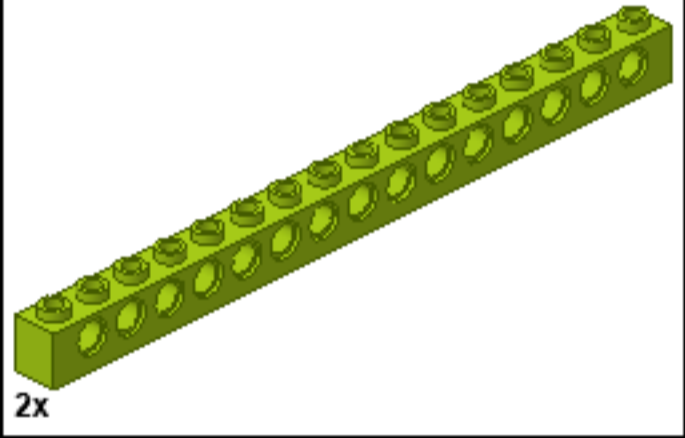

5

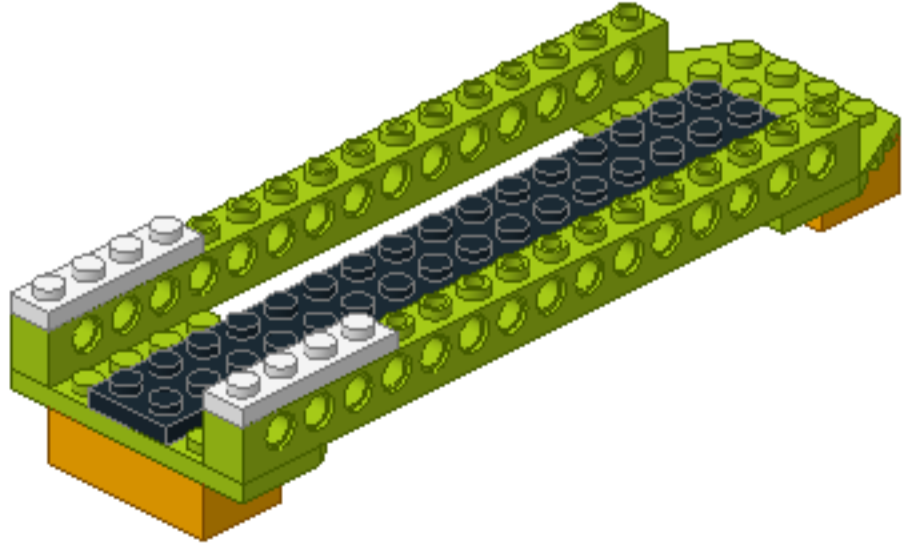
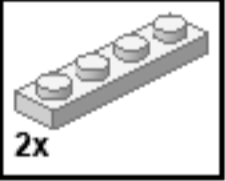

6

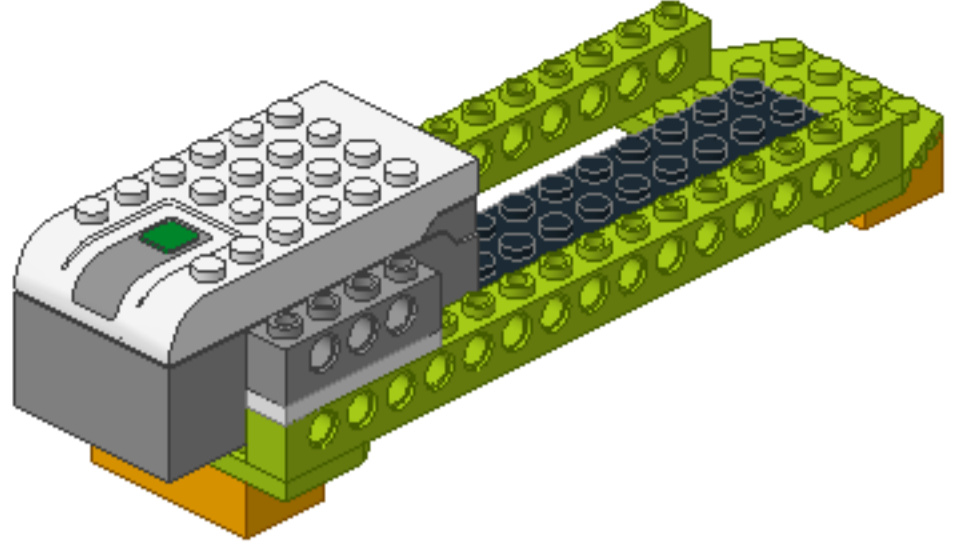
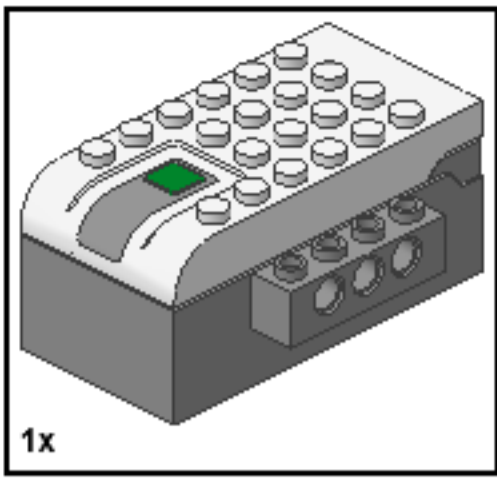

7

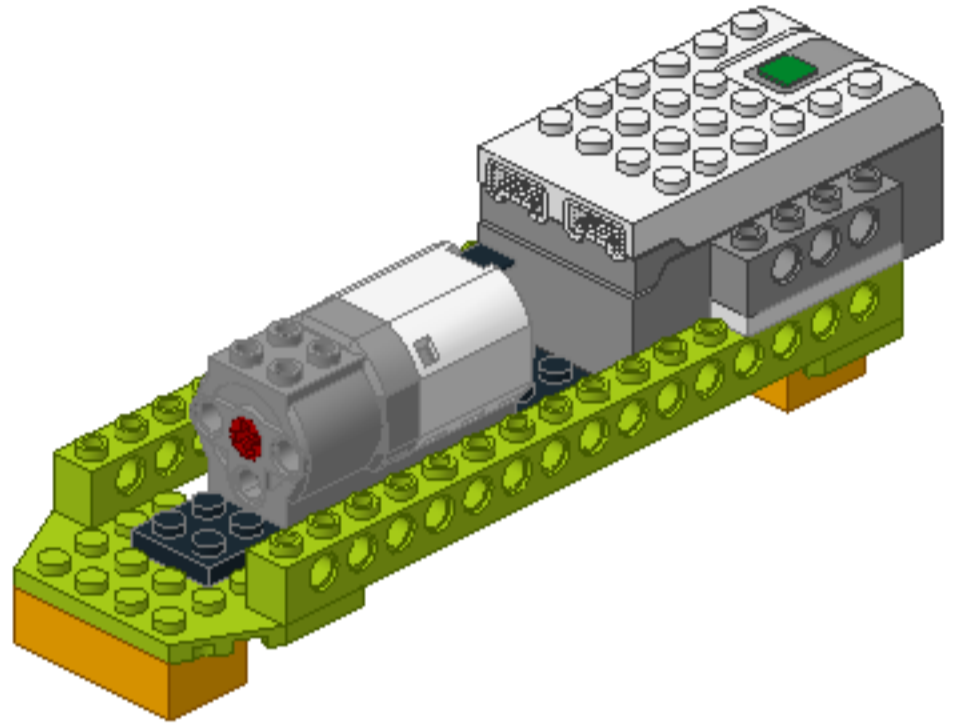
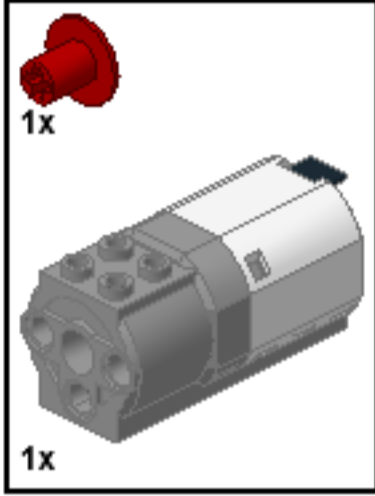

8

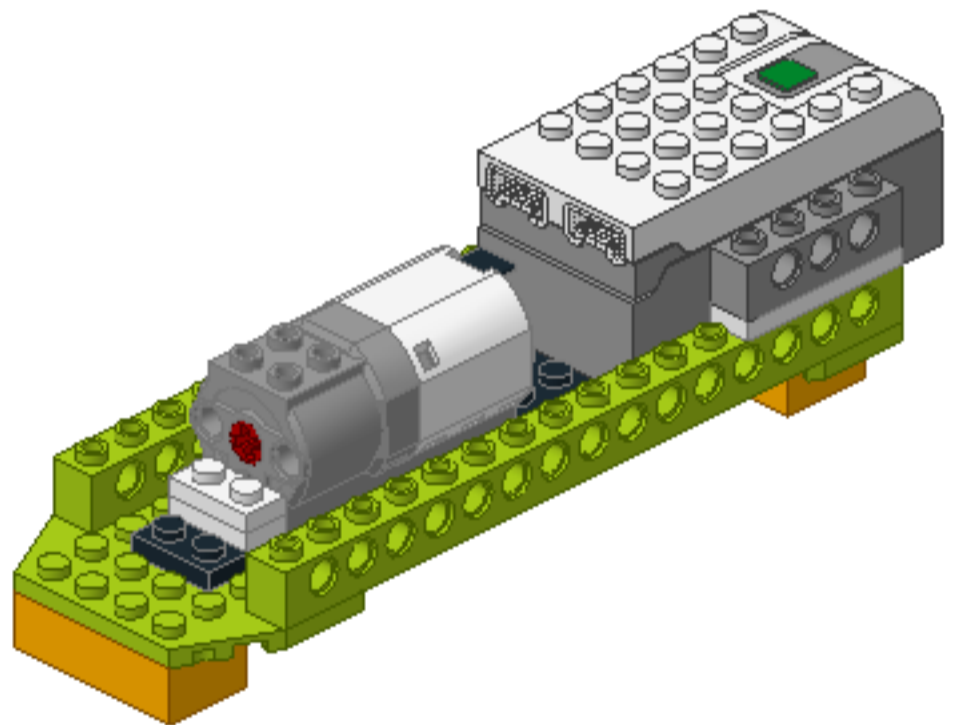
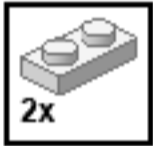

9

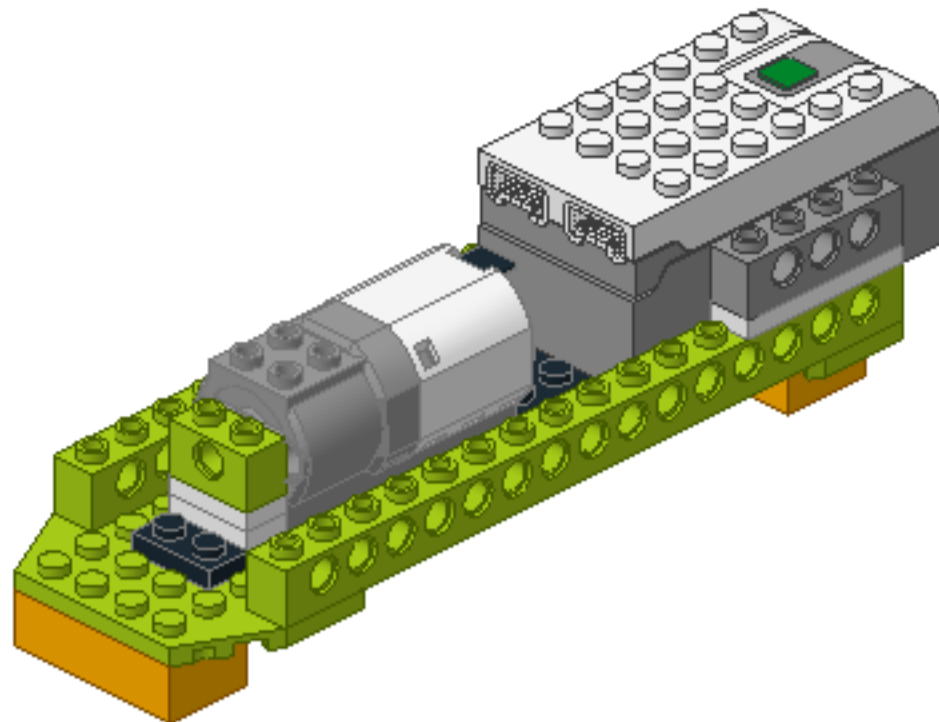
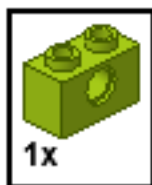

10

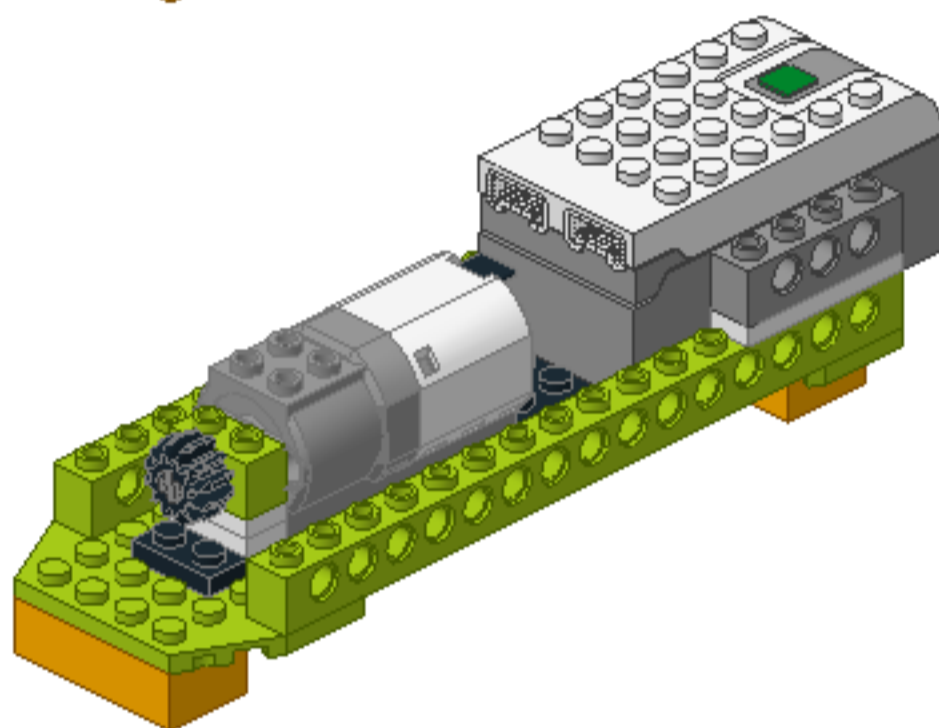
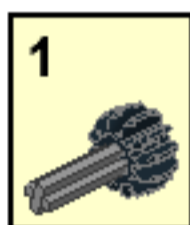
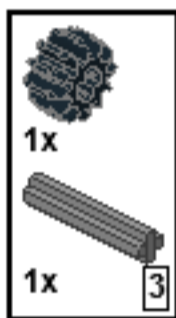

11

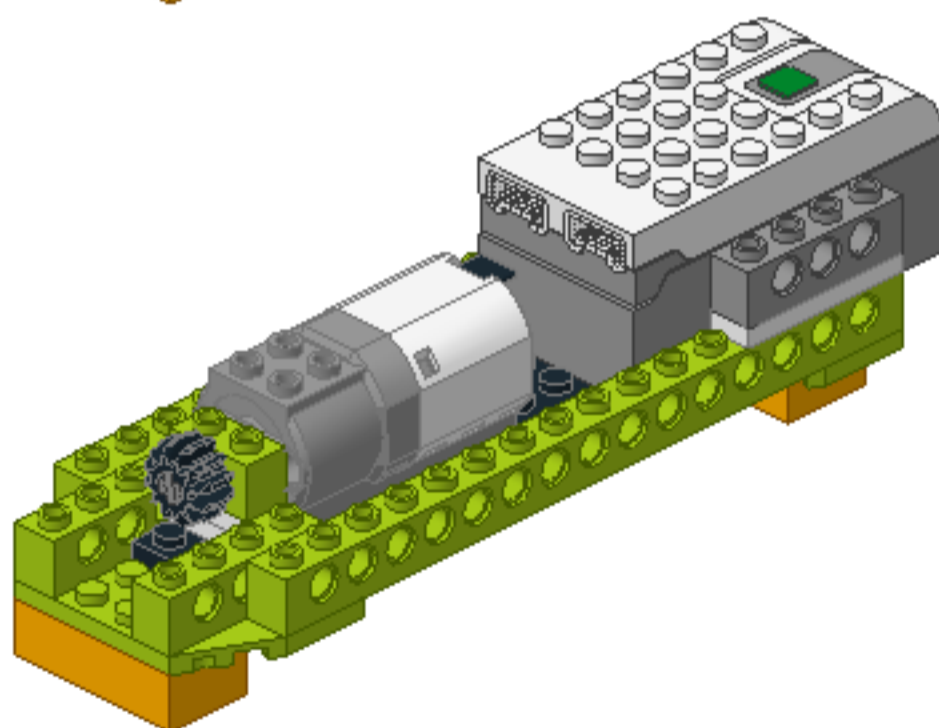
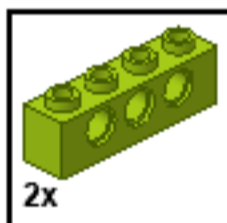

12

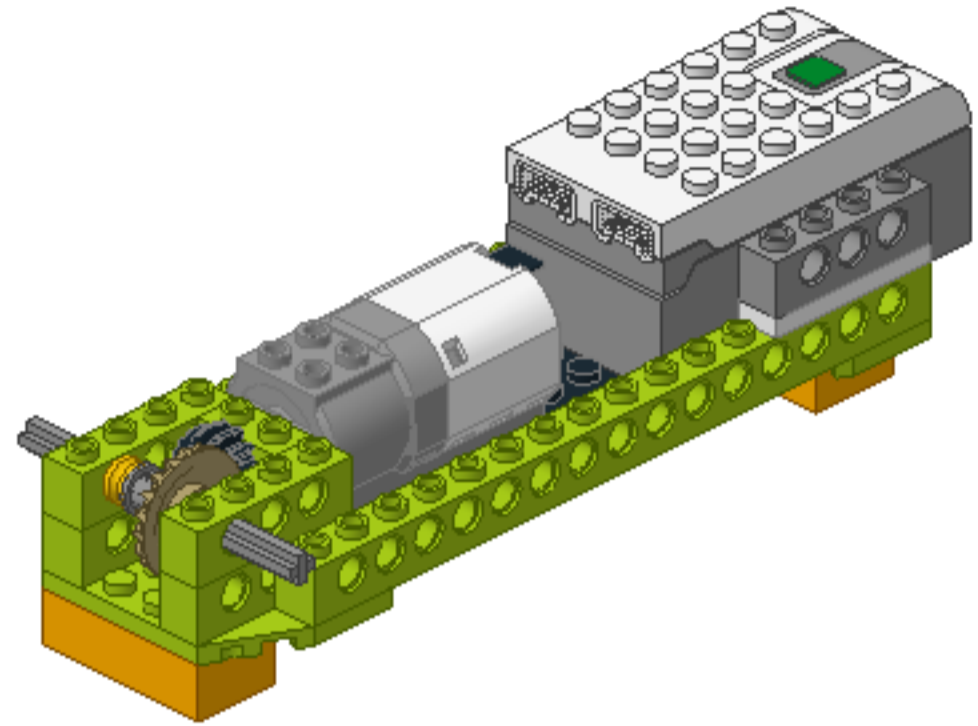
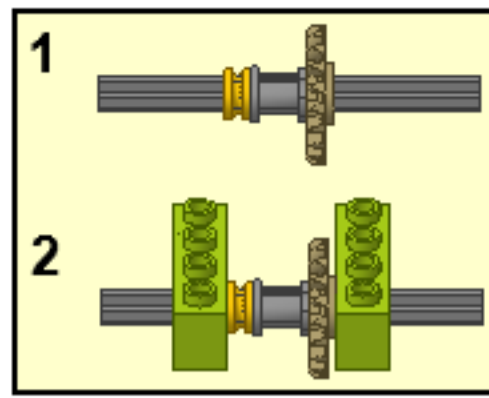
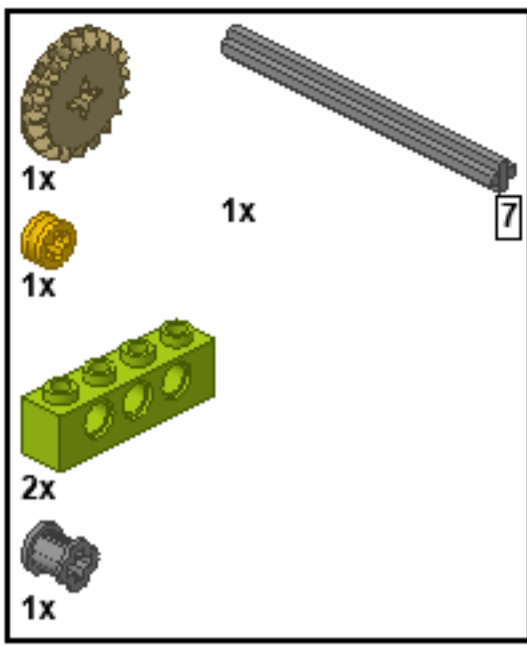

13

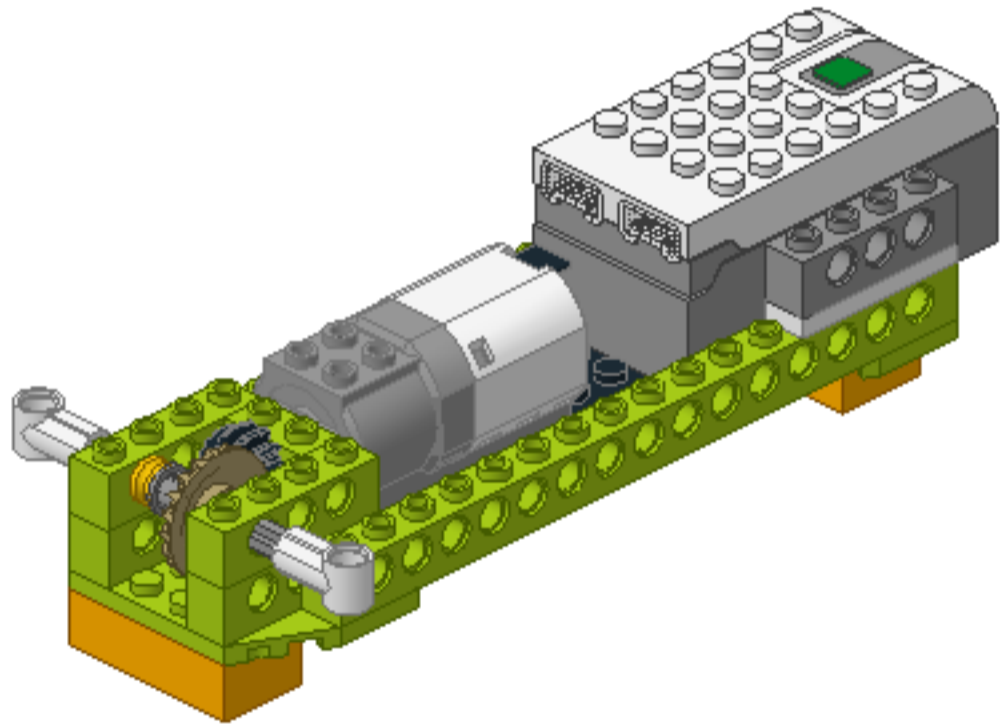
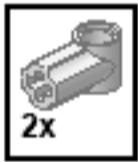

14

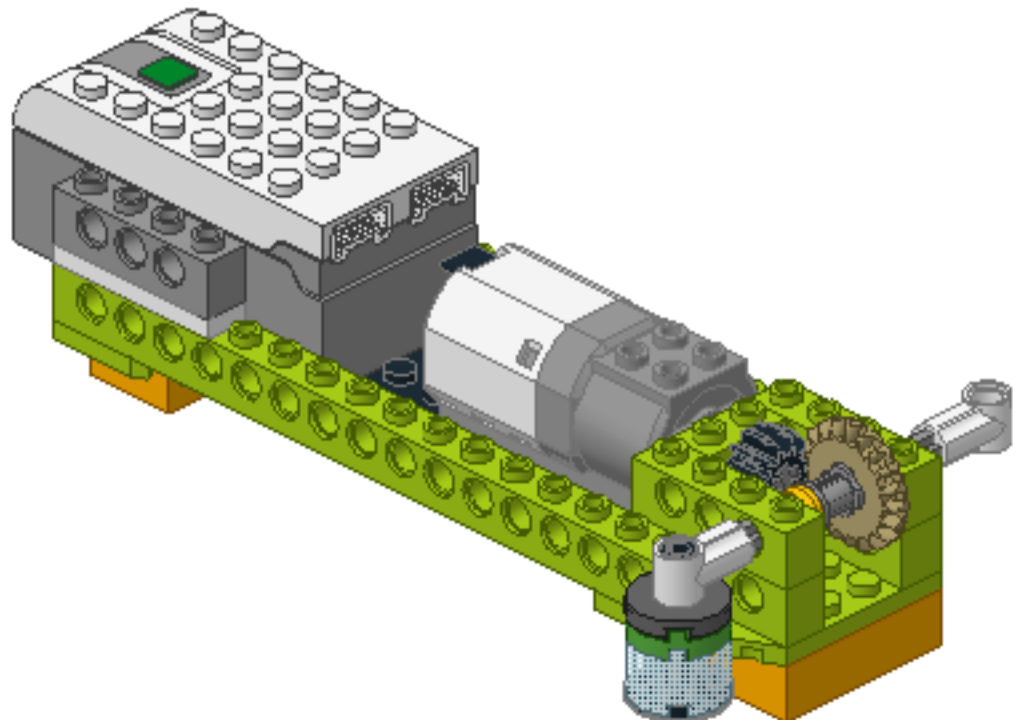
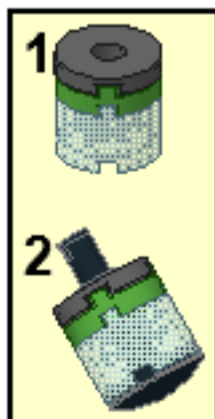
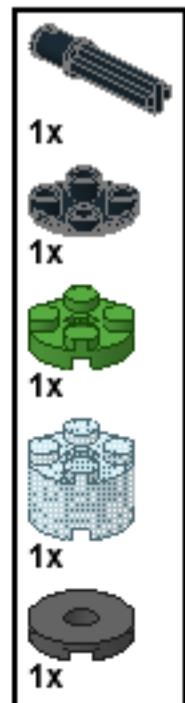

15

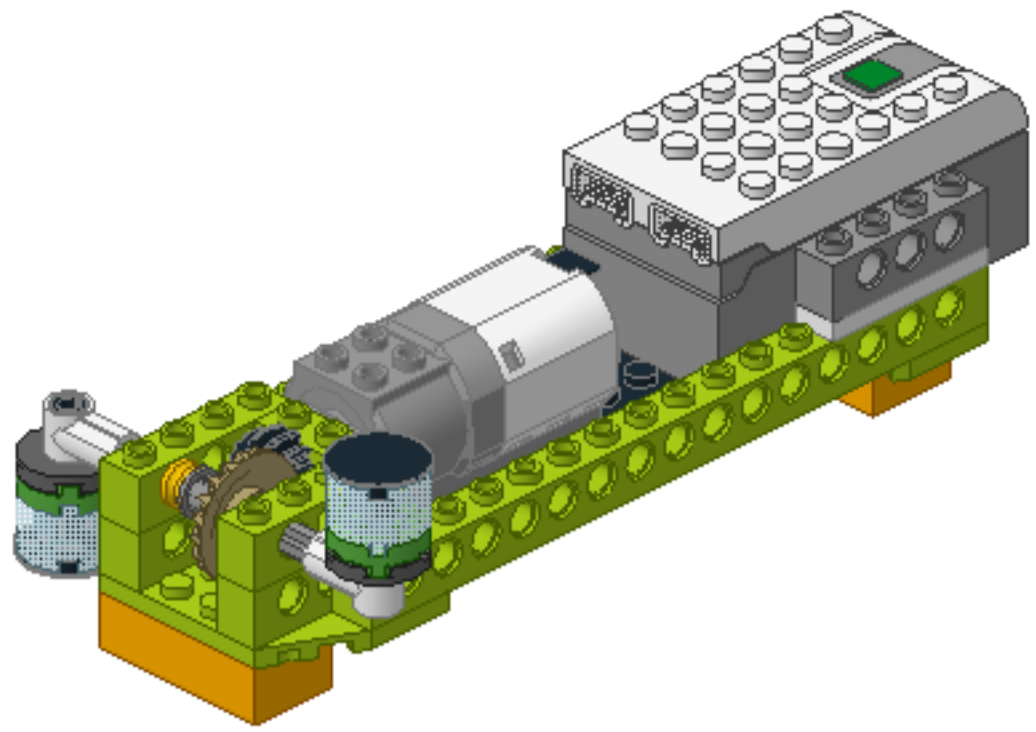
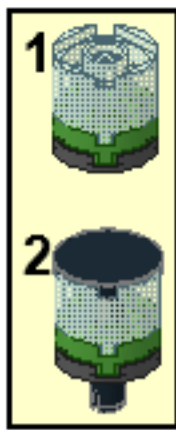

16

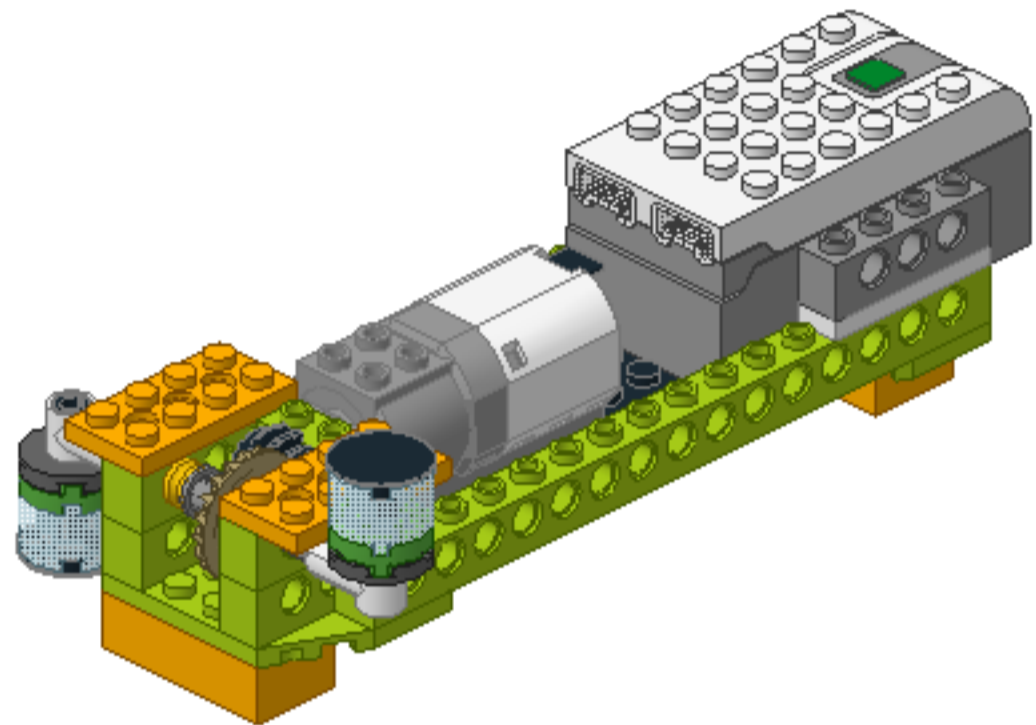
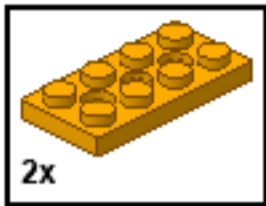

17

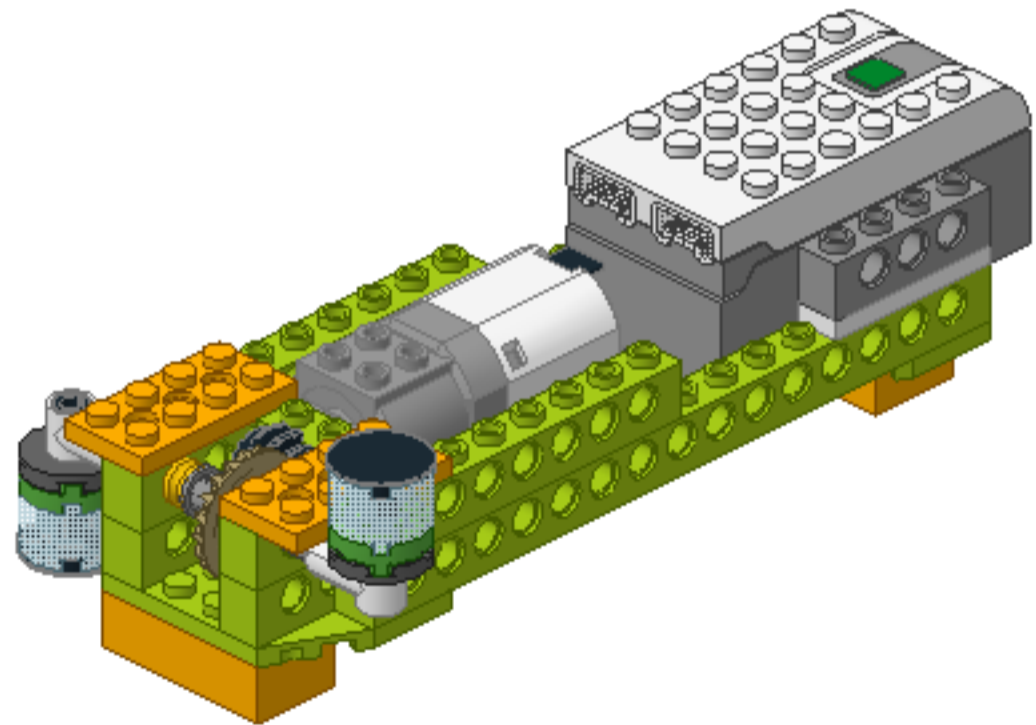
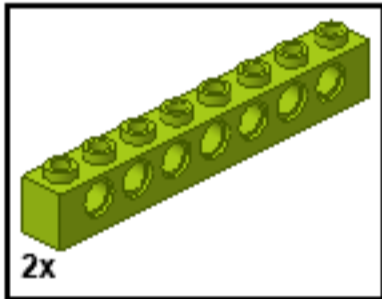

18

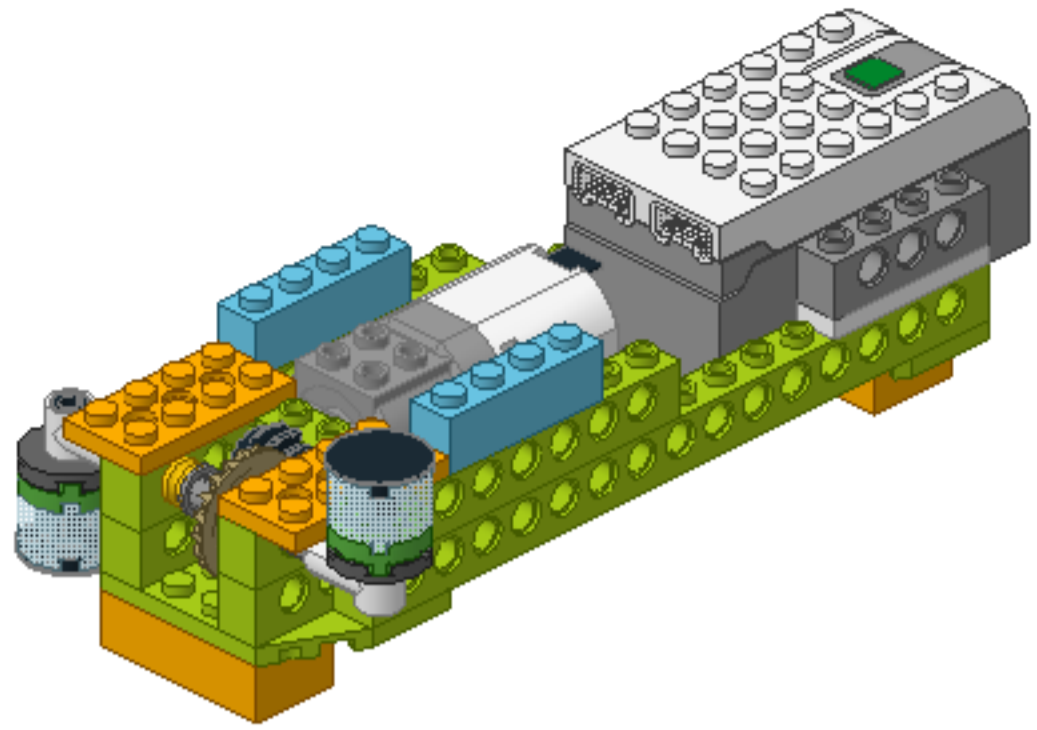
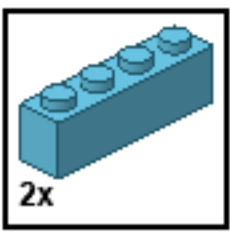

19

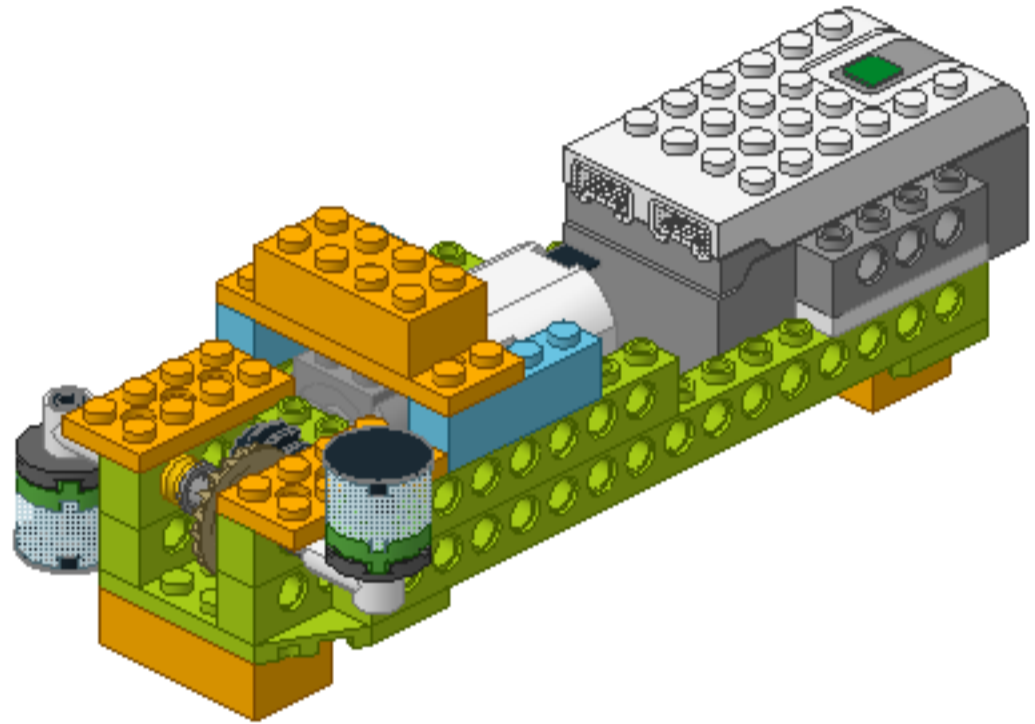
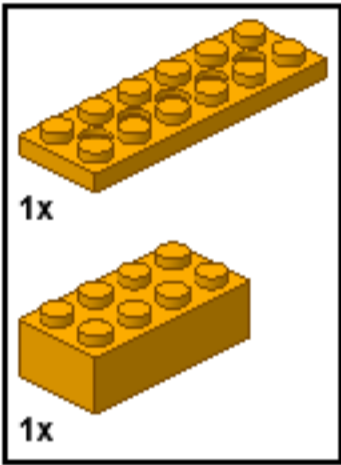

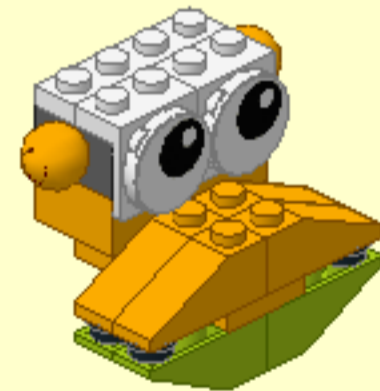
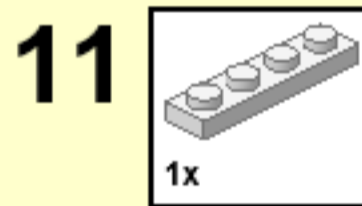
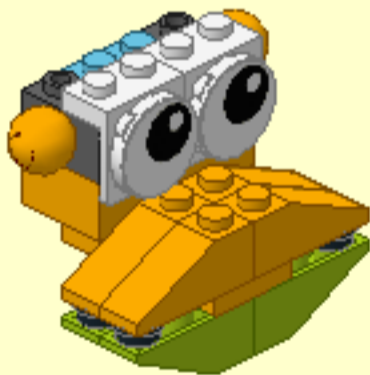
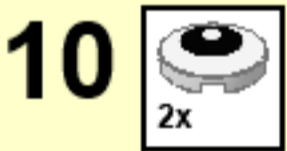
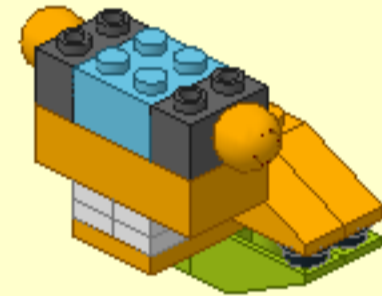
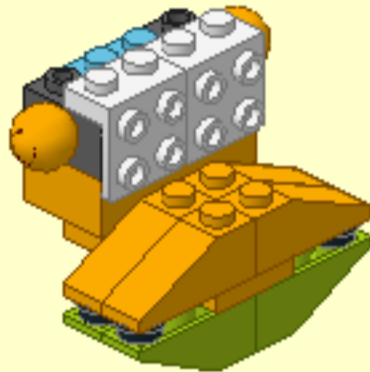
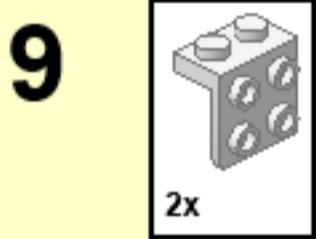
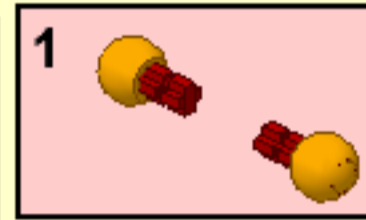
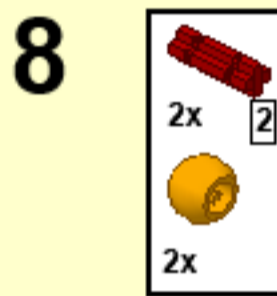
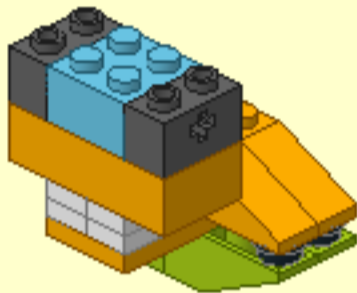
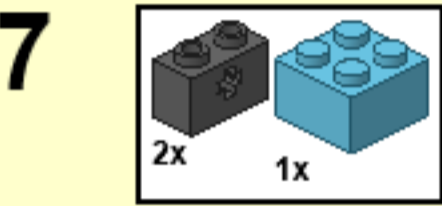
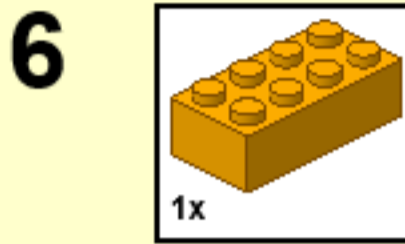
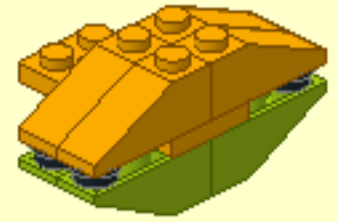

12

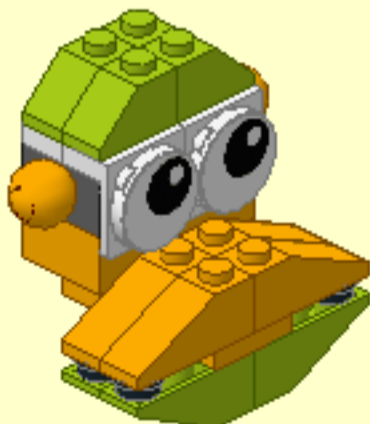

20

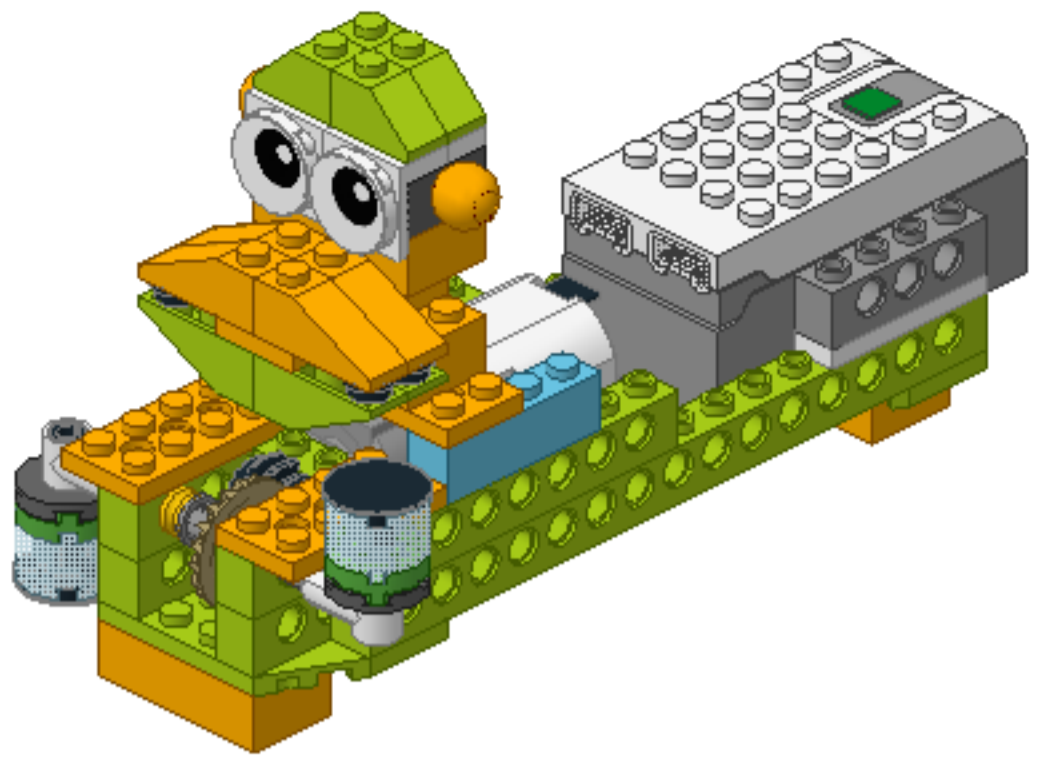
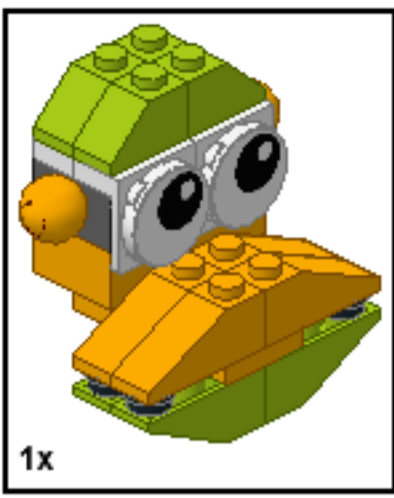

1

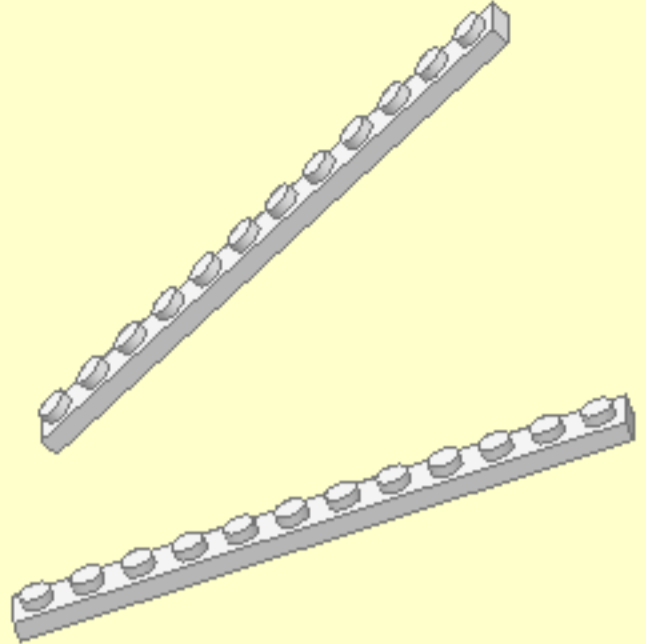
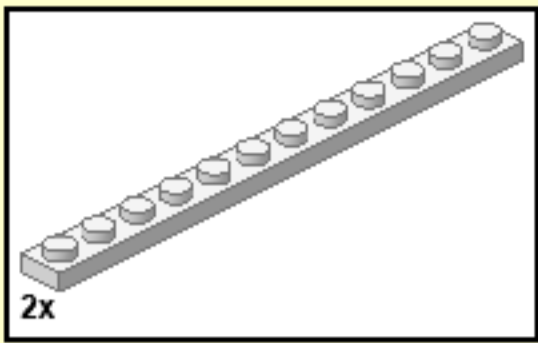

2

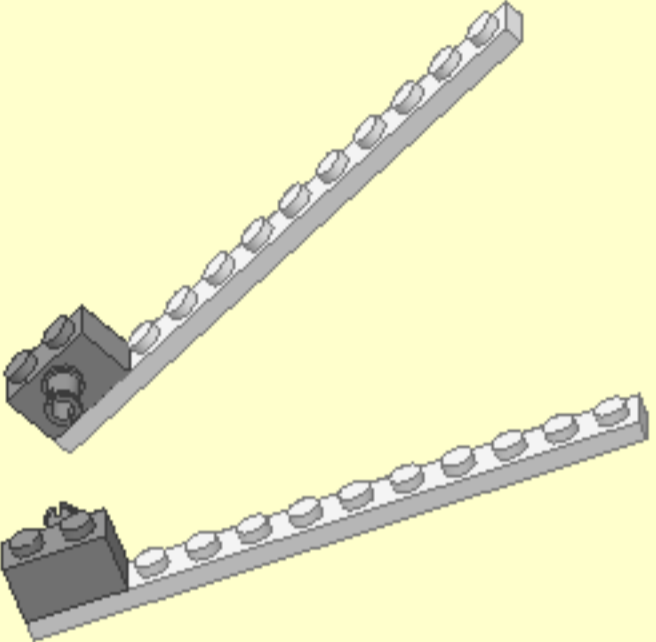
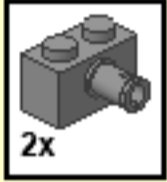

3

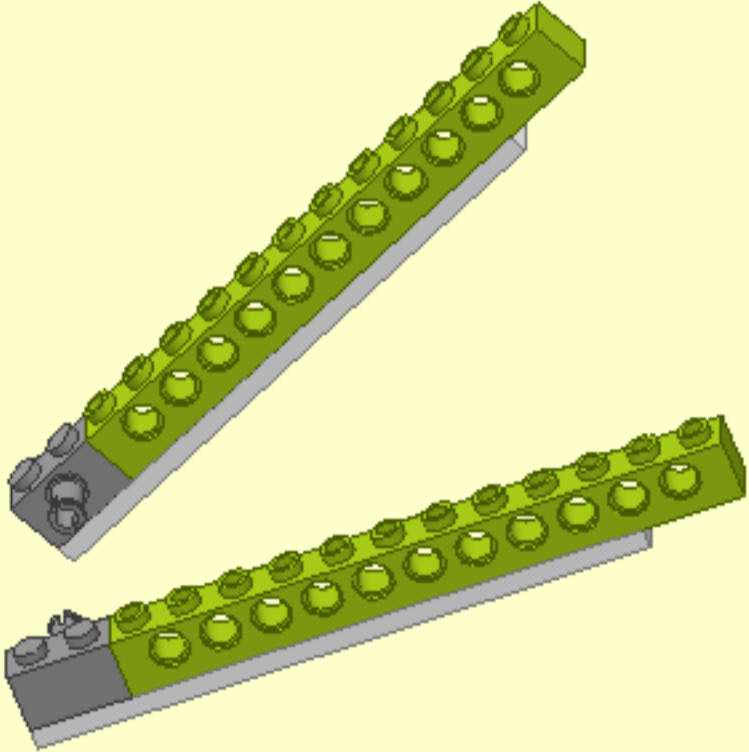
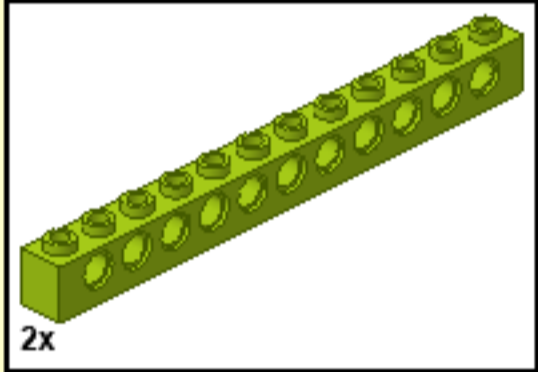

4

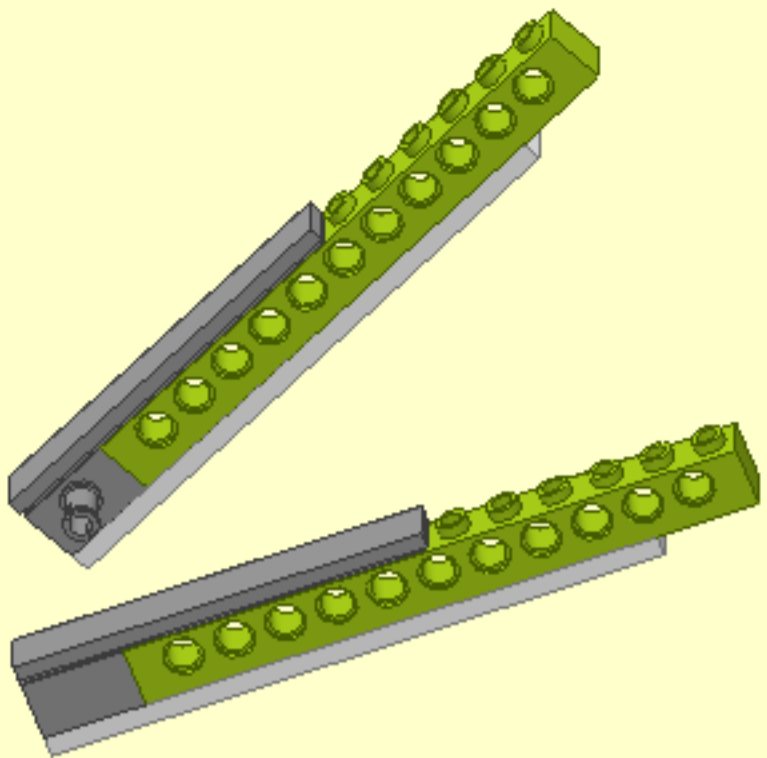
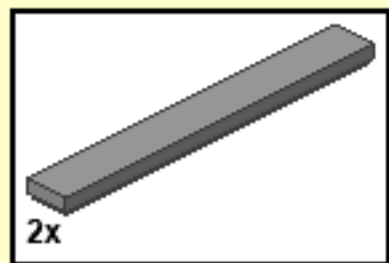

5

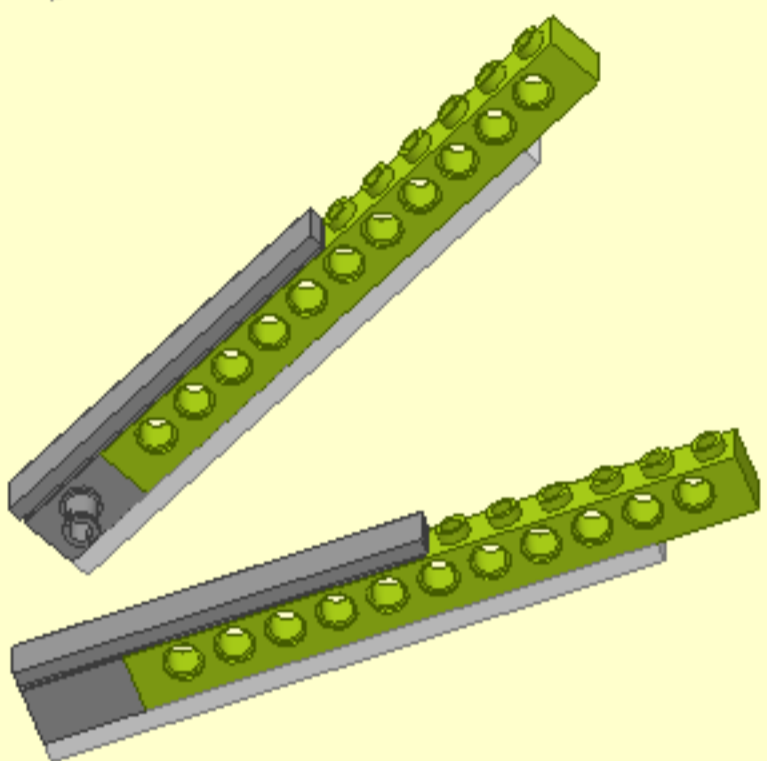

6

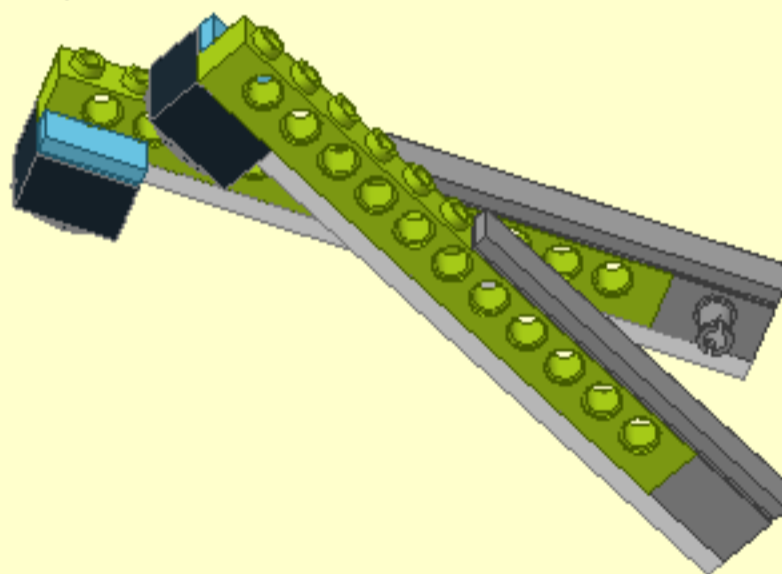
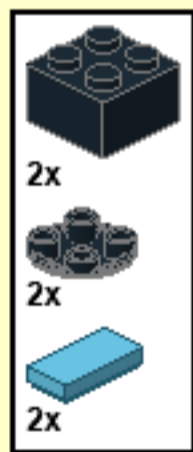

21

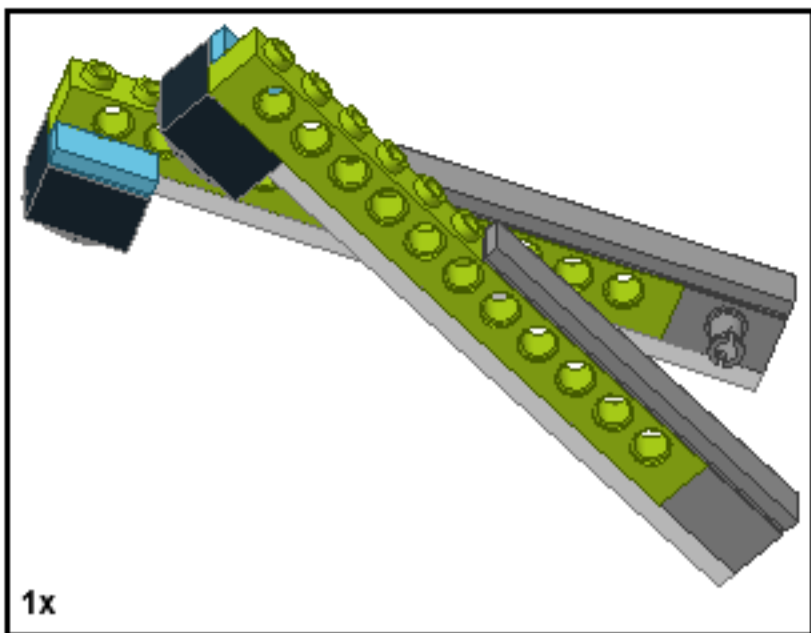

1x

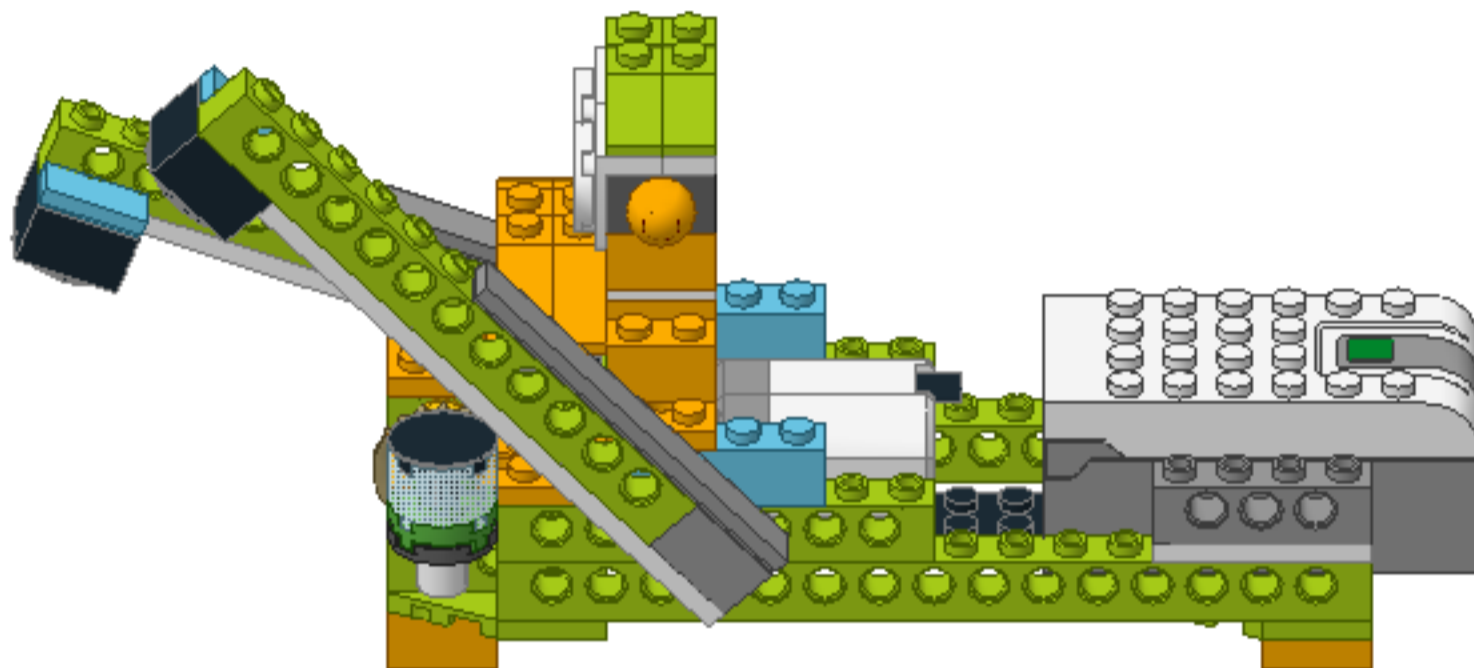

22

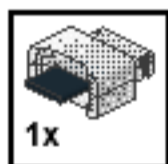

1x

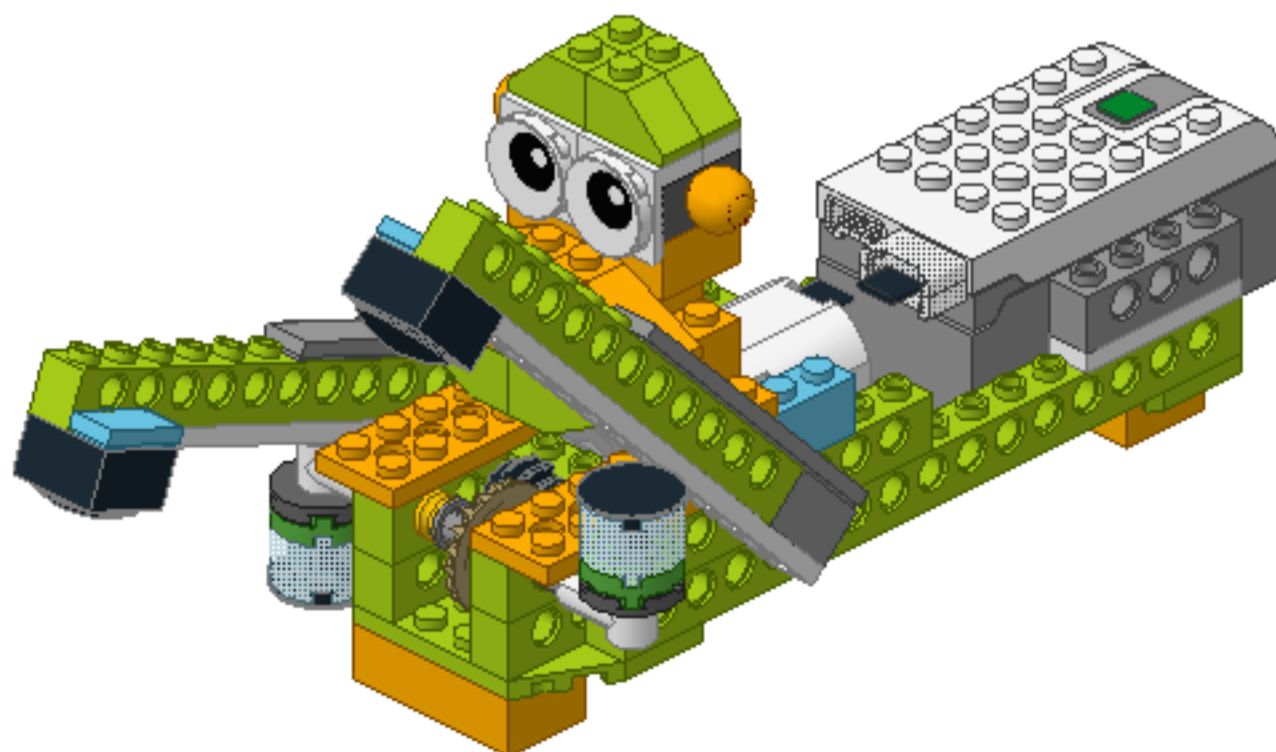



3x



2x



6x



2x



2x

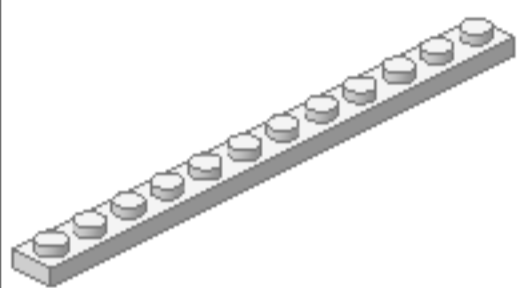

2x



1x



1x



2x

2



1x



1x



1x



2x

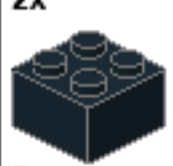

2x

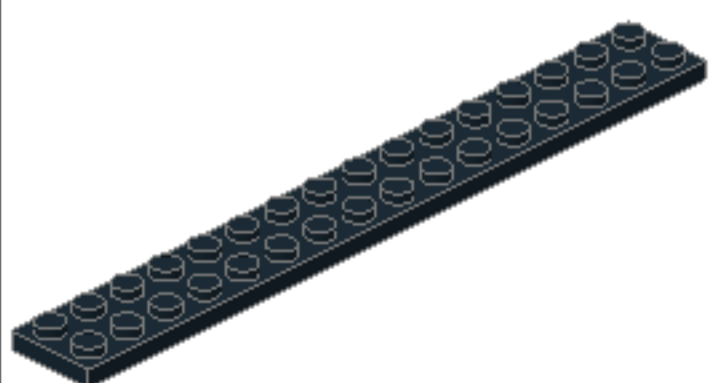

1x



1x



4x



4x



2x

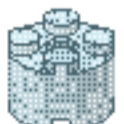

2x

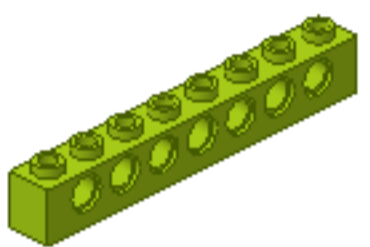

2x



1x

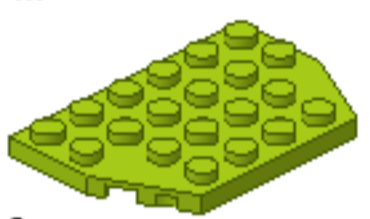

2x



4x

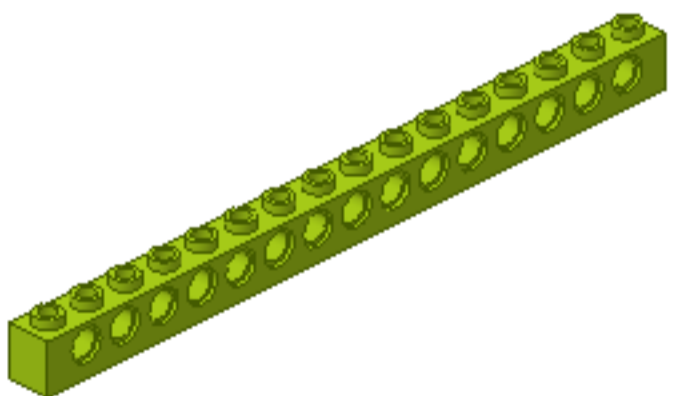

2x

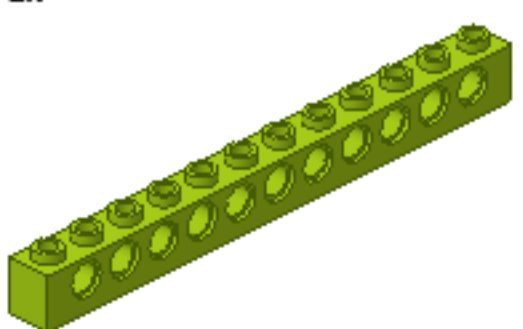

2x



4x



4x

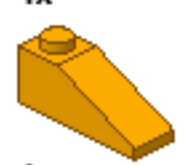

4x

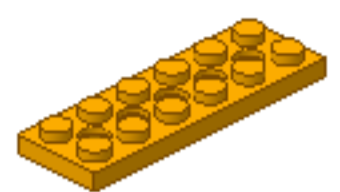

1x



3x



2x



4x

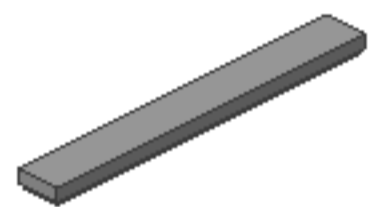

2x



1x

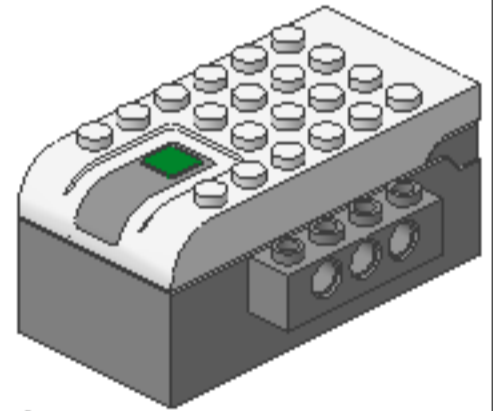

1x

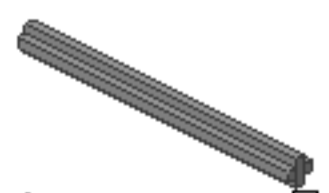

7

1x



2x

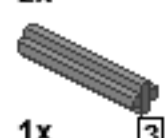

1x

3



2x



2x

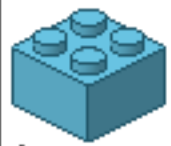

1x



2x

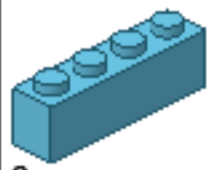

2x